

LOWREY[®] *Virtual Orchestra*

*EZ*¹⁰

Owner's Guide



Thank you for choosing the Lowrey EZ10 Virtual Orchestra for your home!

This guide offers complete operational information to help you enjoy your new musical instrument. Please read the guide and keep it close by for future reference.

Table of Contents

Important Safety Instructions	2	Minor Chord Intro	18
Control Panel	6	Start Stop	18
Let's Get Started	8	Fill	18
Power Button	8	Sounds	19
Home	8	Upper	19
Volume Pedal	8	Organs	19
Master Volume	8	Vibra Trem	20
ABC's	9	Orchestral	20
MCS	9	More	20
Memory	9	Dual Sounds	21
Auto Bass	9	Orchestral On/Off	21
Pedal Magic	9	Orchestral to Right Split	21
Play	10	Harmony	22
Listen	10	Fake It!	23
Headphones	11	Lower	23
Setups	11	Dual Sounds	24
Style Setup	12	Lower Volume	24
Song Setup	12	Glide / Sustain	24
Music Styles	13	Bass/Pedal	25
Style List	13	Bass Volume	25
Selecting A Style	13	Features	26
Style Control	14	1. Keyboard Split	26
Style Volume	14	2. Organs Sustain	27
Drum Volume	15	3. Touch	27
Tempo/Downbeat Indicator	15	4. Drums Only	27
Tempo Control	15	5. Keyed Bass	27
Lock Tempo	15	6. Bass Pedals	28
EASY	15	7. Orch. Octave	28
MCS-Music Chord System	15	8. Orchestral Level	28
Red, Blue, Green	16	9. Transpose	29
<i>Major Chord</i>	16	MCS Chord Chart	30
<i>Minor Chord</i>	16	Song Setup List	31
<i>Seventh Chord</i>	17	Assembling The Bench	32
<i>No Chord</i>	17	Warranty	33
Intro Ending	17		

Original Owner/Purchaser: Register your New EZ10 Lowrey purchase instantly by visiting www.lowrey.com.
Click on the Warranty Registration link at the top of the Lowrey home page.

Important Safety Instructions

SAVE THESE INSTRUCTIONS

INSTRUCTIONS PERTAINING TO A RISK OF FIRE, ELECTRIC SHOCK, OR INJURY TO PERSONS



WARNING

TO REDUCE THE RISK OF FIRE OR ELECTRIC SHOCK, DO NOT EXPOSE THIS PRODUCT TO RAIN OR MOISTURE.

AVIS : RISQUE DE CHOC ELECTRIQUE - NE PAS OUVRIR.

TO REDUCE THE RISK OF ELECTRIC SHOCK, DO NOT REMOVE COVER (OR BACK).
NO USER-SERVICEABLE PARTS INSIDE. REFER SERVICING TO QUALIFIED SERVICE PERSONNEL.



The lightning flash with arrowhead symbol, within an equilateral triangle, is intended to alert the user to the presence of uninsulated "dangerous voltage" within the product's enclosure that may be of sufficient magnitude to constitute a risk of electric shock to persons.



The exclamation point within an equilateral triangle is intended to alert the user to the presence of important operating and maintenance (servicing) instructions in the literature accompanying the product.

Examples of Picture Symbols



denotes that care should be taken.
The example instructs the user to take care not to allow fingers to be trapped.



denotes a prohibited operation.
The example instructs that disassembly of the product is prohibited.



denotes an operation that should be carried out.
The example instructs the user to remove the power cord plug from the AC outlet.

Read all the instructions before using the product.

- 1) Read these instructions.
- 2) Keep these instructions.
- 3) Heed all warnings.
- 4) Follow all instructions.
- 5) Do not use this apparatus near water.
- 6) Clean only with dry cloth.
- 7) Do not block any ventilation openings. Install in accordance with the manufacturer's instructions.
- 8) Do not install near any heat sources such as radiators, heat registers, stoves, or other apparatus (including amplifiers) that produce heat.
- 9) Do not defeat the safety purpose of the polarized or grounding-type plug. A polarized plug has two blades with one wider than the other. A grounding type plug has two blades and a third grounding prong. The wide blade or the third prongs are provided for your safety. If the provided plug does not fit into your outlet, consult an electrician for replacement of the obsolete outlet.
- 10) Protect the power cord from being walked on or pinched particularly at plugs, convenience receptacles, and the point where they exit from the apparatus.
- 11) Only use attachments/accessories specified by the manufacturer.
- 12) Use only with the cart, stand, tripod, bracket, or table specified by the manufacturer, or sold with the apparatus. When a cart is used, use caution when moving the cart/apparatus combination to avoid injury from tip-over. 
- 13) Unplug this apparatus during lightning storms or when unused for long periods of time.
- 14) Refer all servicing to qualified service personnel. Servicing is required when the apparatus has been damaged in any way, such as power-supply cord or plug is damaged, liquid has been spilled or object have fallen into the apparatus, the apparatus has been exposed to rain or moisture, does not operate normally, or has been dropped.

WARNING - When using electric products, basic precautions should always be followed, including the following.



WARNING

Indicates a potential hazard that could result in death or serious injury if the product is handled incorrectly.

The product should be connected to an AC outlet of the specified voltage.



- If you are going to use an AC power cord, make sure that its has the correct plug shape and conforms to the specified power voltage.
- Failure to do so may result in fire.

Do not insert or disconnect the power cord plug with wet hands.



Doing so may cause electric shock.

Take care not to allow any foreign matter to enter the product.



Entry of water, needles or hair pins may result in breakdown or short-circuit. The product shall not be exposed to dripping or splashing. No objects filled with liquids, such as vases, shall be placed on the product.

The chair must be used properly (it must be used only when playing the product).

- Do not play with it or stand on it.
- Only one person is allowed to sit on it.
- Do not sit on it when opening the lid.
- Re-tighten the bolts occasionally.

Doing so may cause the chair to fall over or your fingers to be trapped, resulting in injury.

When using the headphones, do not listen for long periods of time at high volume levels.

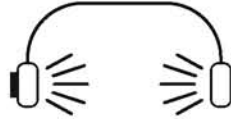

Doing so may result in hearing problems.

Do not lean against the keyboard.



Doing so may cause the product to fall over, resulting in injury.

Do not disassemble, repair or modify the product.



Doing so may result in product breakdown, electric shock or short-circuit.

When disconnecting the AC power cord's plug, always hold the plug and pull it to remove it.



- Pulling the AC power cord itself may damage the cord, causing a fire, electric shock or short-circuit.

The product is not completely disconnected from the power supply even when the power switch is turned off. If the product will not be used for a long time, unplug the AC power cord from the AC outlet.



- Failure to do so may cause fire in case of lightning.
- Failure to do so may over-heat the product, resulting in fire.

This product may be equipped with a polarized line plug (one blade wider than the other). This is a safety feature. If you are unable to insert the plug into the outlet, contact an electrician to replace your obsolete outlet. Do not defeat the safety purpose of the plug.

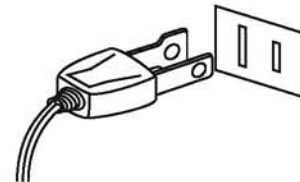

This product shall be near the AC outlet and the power cord plug in a position so that it can readily be disconnected in an emergency because electricity is always charging while the plug is in the AC outlet even in a power switch off condition.



CAUTION

Indicates a potential hazard that could result in injury or damage to the product or other property if the product is handled incorrectly.

Do not use the product in the following areas.

- Areas, such as those near windows, where the product is exposed to direct sunlight
- Extremely hot areas, such as near a heater
- Extremely cold areas, such as outside
- Extremely humid areas
- Areas where a large amount of sand or dust is present
- Areas where the product is exposed to excessive vibrations

Using the product in such areas may result in product breakdown. Use the product only in moderate climates (not in tropical climates).

Before connecting cords, make sure that the power to this product and other devices is turned OFF.



Failure to do so may cause breakdown of this product and other devices.

Do not drag the product on the floor. Take care not to drop the product.



Please lift up the product when moving it. Please note that the product is heavy and must be carried by more than two persons. Dropping the product may result in breakdown.

Do not place the product near electrical appliances such as TVs and radios.



- Doing so may cause the product to generate noise.
- If the product generates noise, move the product sufficiently away from the electrical appliance or connect it to another AC outlet.

When connecting the AC power cord and other cords, take care not to get them tangled.



Failure to do so may damage them, resulting in fire, electric shock or short-circuit.

Do not wipe the product with benzene or thinner.



- Doing so may result in discoloration or deformation of the product.
- When cleaning the product, put a soft cloth in lukewarm water, squeeze it well, then wipe the product.

Do not stand on the product or exert excessive force.



- Doing so may cause the product to become deformed or fall over, resulting in breakdown or injury.

Do not place naked flame, such as lighted candles on the product.

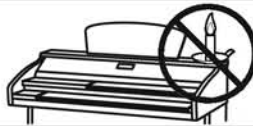

Doing so may cause the illumination to fall over, resulting in fire.

Ensure that the ventilation is not impeded by covering the ventilation openings with items, such as newspaper, table-cloths, curtains, etc.

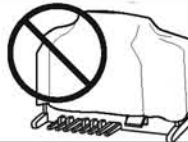

Failure to do so may over-heat the product, resulting in fire.

The product should be located so that its location or position does not interfere with its proper ventilation. Ensure a minimum distance of 5cm around the product for sufficient ventilation.

The product should be serviced by qualified service personnel when:

- The power supply cord or the plug has been damaged.
- Objects have fallen, or liquid has been spilled into the product.
- The product has been exposed to rain.
- The product does not appear to operate normally or exhibits a marked change in performance.
- The product has been dropped, or the enclosure damaged.

Notes on Repair

Should an abnormality occur in the product, immediately turn the power OFF, disconnect the power cord plug, and then contact the shop from which the product was purchased.

CAUTION:

To prevent electric shock, match wide blade of plug to wide slot, fully insert.

ATTENTION:

Pour éviter les chocs électriques, introduire la lame la plus large de la fiche dans la borne correspondante de la prise et pousser jusqu'au fond.



An information on Disposal for users

If your product is marked with this recycling symbol it means that, at the end of its life, you must dispose of it separately by taking it to an appropriate collection point.

You should not mix it with general household waste. Disposing of this product correctly will prevent potential negative effects on the environment and human health which could otherwise arise due to inappropriate waste handling. For further details, please contact your local authority. (European Union only)

Instruction for AC power cord (U.K.)

IMPORTANT

THE WIRES IN THIS MAINS LEAD ARE COLOURED IN ACCORDANCE WITH THE FOLLOWING CODE.

- BLUE : NEUTRAL
- BROWN : LIVE

As the colours of the wires in the mains lead of this apparatus may not correspond with the coloured markings identifying the terminals in your plug, proceed as follows:

The wire which is coloured BLUE must be connected to the terminal which is marked with the letter N or coloured BLACK. The wire which is coloured BROWN must be connected to the terminal which is marked with the letter L or coloured RED. Do not plug either terminal of the power cord to the the ground od AC outlet on the wall.

Canadian Radio Interference Regulations

This instrument complies with the limits for a class B digital apparatus, pursuant to the Radio Interference Regulations, C.R.C., c. 1374.

FCC Information (U.S.A)

CAUTION : Changes or modifications not expressly approved by the party responsible for compliance could void the user's authority to operate the equipment.

NOTE : This equipment has been tested and found to comply with the limits for a Class B digital device, pursuant to Part 15 of the FCC Rules. These limits are designed to provide reasonable protection against harmful interference in a residential installation. This equipment generates, uses and can radiate radio frequency energy and, if not installed and used in accordance with the instructions, may cause harmful interference to radio communications. However, there is no guarantee that interference will not occur in a particular installation. If this equipment does cause harmful interference to radio or television reception, which can be determined by turning the equipment off and on, the user is encouraged to try to correct the interference by one or more of the following measures:

- Reorient or relocate the receiving antenna.
- Increase the separation between the equipment and receiver.
- Connect the equipment into an outlet on a circuit different from that to which the receiver is connected.
- Consult the dealer or an experienced radio/TV technician for help.

Declaration of Conformity

Products :	Electronic Organ
Model Number :	EZ10
Responsible Party Name :	Lowrey Organ Company
Address :	847 North Church Court Elmhurst, Illinois, 60126-1036
Telephone	708-352-3388

This device complies with Part 15 of the FCC Rules.

Operation is subject to the following two conditions:

- (1) this device may not cause harmful interference, and
- (2) this device must accept any interference received, including interference that may cause undesired operation.

The nameplate label is located on the underside of the keyboard shelf, as shown below.

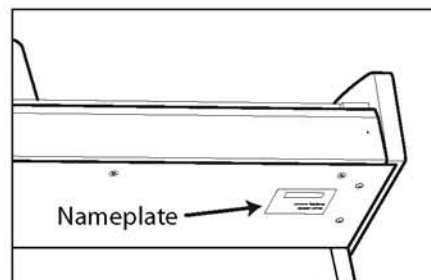

This applies only to products distributed by Lowrey Organ Company.

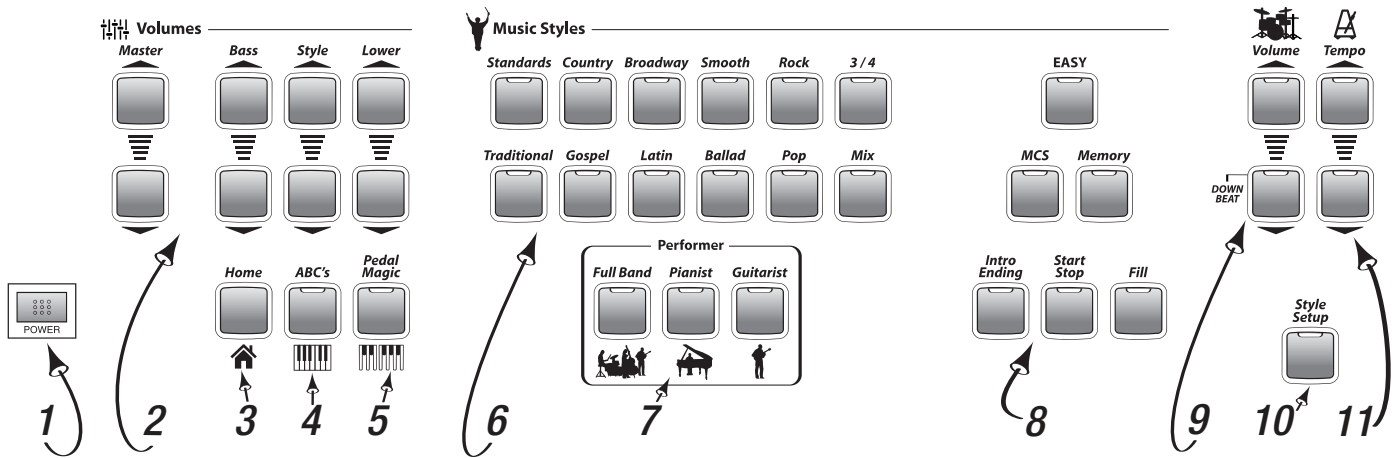

1. Power - Page 8

2. Volumes - Page 8, 14, 24, 25

Control the volume level of various sections of the EZ10.

3. Home - Page 8

Pressing the Home button returns the EZ10 to its original power on setting.

4. ABC's - Page 9

Illuminate the musical alphabet to guide your playing.

5. Pedal Magic - Page 9

Always play the right bass note.

6. Music Styles - Page 13

Select fully-orchestrated musical accompaniments.

7. Performer - Page 13

Each Music Style features three distinctive types of orchestration: Full Band, Pianist or Guitarist.

8. Style Controls - Page 14

Control aspects of each Style.

Intro Ending - Add a professionally composed Introduction and Ending to your songs.

Start Stop - Starts and Stops a Style.

Fill - Add a rhythmic break or fill-in to your song.

Easy activates Lowrey easy play features: MCS Chords, Chord Memory and Auto Bass.

MCS - Individual control of the easy play chord feature.

Memory - Individual control of the chord memory feature.

9. Drum Volume - Page 15

Control the volume level of the drums portion of a Music Style.

10. Style Setup - Page 12

Select from among six complete sound presets for each Music Style.

11. Tempo - Page 15

Speed up or slow down the tempo of any Music Style. Tempo value is shown in the display.

Control Panel

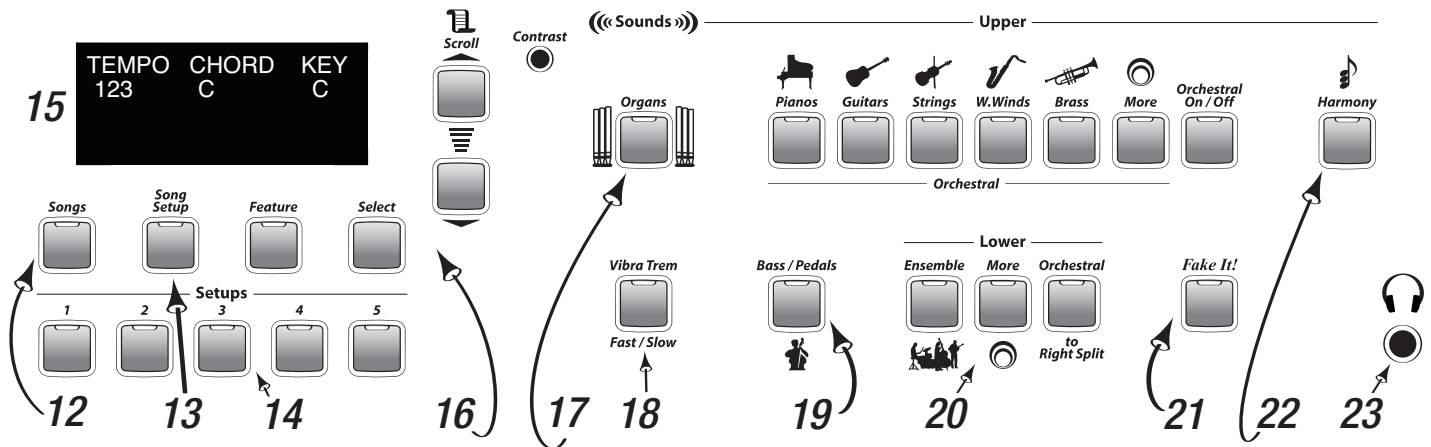

12. Songs - Page 10

Listen to prerecorded musical performances loaded in the EZ10.

13. Song Setup - Page 12

Select a complete sound preset for a song from a list of titles loaded in the EZ10.

14. Setups - Page 11

Select a from among six complete sound presets.

15. Display

Used along with many features. Shows data, values and feature choices.

16. Feature Controls - Page 26

Scroll - show different feature options

Select - Implement a feature option

Feature - A list of EZ10 control parameters

Contrast - Set the display contrast

17. Sounds - Page 19

Select from a variety of musical instrument sounds for the upper keyboard.

18. Vibra Trem - Page 20

Adds motion to organ sounds.

19. Bass / Pedals - Page 25

Select from a variety of musical instrument sounds for the bass pedals.

20. Lower - Page 23

Select from a variety of musical instrument sounds for the lower keyboard.

21. Fake It! - Page 23

Add solos and 'riffs' to your music with just one finger.

22. Harmony - Page 22

Select different types of one finger harmonies.

23. Headphones - Connect a set of stereo headphones.

Let's Get Started

Power

Turn the EZ10 on by pressing the **Power** button on the left end of the control panel. The instrument will fully power up in just a few seconds. An **Orchestra** sound is on the upper keyboard. A **Grand Piano** sound is on the lower keyboard. **Orchestra** and **Piano** is the **Power On** setup.

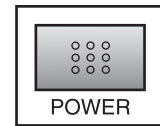

Home

Press the **Home** button anytime to return the EZ10 to the original **Power On** setup.



Volume Pedal

Place your right foot on the **Volume Pedal** while playing. Moving this pedal controls the overall volume level of the EZ10.

- Pressing the pedal all the way down is maximum volume.
- Pressing the pedal all the way back is minimum volume.

The **Volume Pedal** allows the player to add expression (changes in the volume level) to their music.

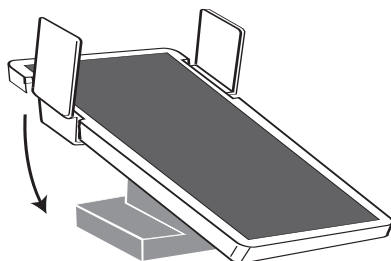
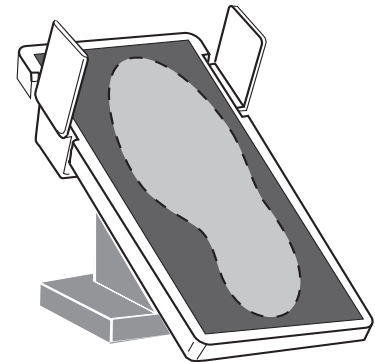

Pedal Set to Maximum Volume

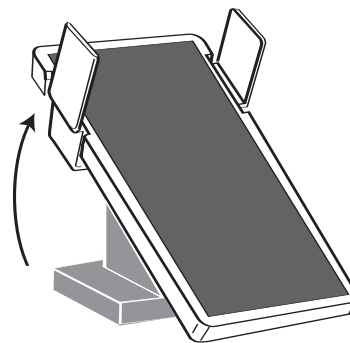

Pedal Set to Minimum Volume

When the **Volume Pedal** volume level is too loud, or too soft, use the **Master Volume** control to decrease or increase the volume level.

- The top button increases the volume level.
 - The bottom button decreases the volume level.
- You may need to press either button several times to reach the desired level.

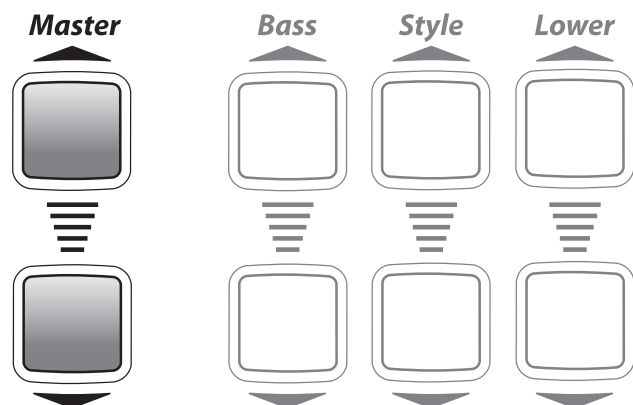

ABC's

Each key on the EZ10 is clearly labeled with a lighted musical alphabet. Press the button to turn the lights on and off.



MCS

MCS - Music Chord System is Lowrey's easy-play feature that makes playing left hand chords easy. With MCS, you can play major chords with just one finger and obtain a full-sounding, musically correct chord. MCS also becomes active when you press the **Easy** button or select a **Music Style**. When MCS is active the **Red, Blue, and Green Chord Lights** above the lower keyboard become illuminated. These lights match the color-coded bars printed in the music of your Lowrey Songbook and in Lowrey Magic class books. Red is for C, blue is for F, and green is for G chords. *See page 15.*

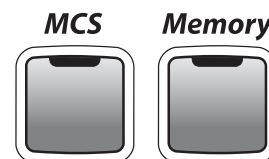

Memory

Memory continues sounding the last MCS chord played, even after the key or keys have been released. This feature frees your hand to turn a page of music or prepare for the next chord to be played. **Chord Memory** also becomes active when you press the **Easy** button or select a **Music Style**.

Auto Bass

Auto Bass is the feature that plays bass along with you automatically, creating a full, rich sound. **Auto Bass** is not a button. It is a feature that becomes active when you press the **Easy** button or select a **Music Style** and play a lower keyboard/left hand chord. When you play your own bass pedals Auto Bass stops in order for your playing to take priority. When you stop playing bass pedals Auto Bass begins to play again.

Pedal Magic

Pedal Magic enables you to play bass pedals and always play the right note. While playing a lower keyboard/left hand chord (MCS or conventional) press any pedal with your foot in the tempo you desire.



- A long pedal will be the root note of your left hand chord.
- A short pedal will be the 5th of your left hand chord.

Try alternating between any long and short pedal in tempo with a **Music Style**.

When using **Pedal Magic** without a **Music Style** turn off the **Easy** button to silence the Auto Bass feature.

Play

There are 20 songs in the Lowrey Songbook (that is included with the purchase of the EZ10) with color-coded MCS chord bars. Your right plays the ABC's and your left plays the color-coded chords.

ABC's and **Color-Coded Chords** are used throughout **Lowrey Magic**, a leading recreational music making class, which focuses on providing a unique and accessible opportunity for each person to become musical in their own way rather than emphasizing the conventional method of musical competition and performance.

Listen

Performance of a demonstration song and 39 songs from the first four books of the Lowrey Magic course are in the EZ10.

- Press the **Songs** button. The **Display** will show **Demo Songs**.
- Press the bottom **Scroll** button for **Chain Loop**, which will play all 40 titles in sequence repeatedly. To begin **Chain Loop** play press the **Start/Stop** or **Select** button.
- Press the **Start/Stop** button to end play.
- To play individual titles press either **Scroll** button to select single titles. Press a **Scroll** button repeatedly to find the desired title.
- Press **Start/Stop** or **Select** to begin play of the title.

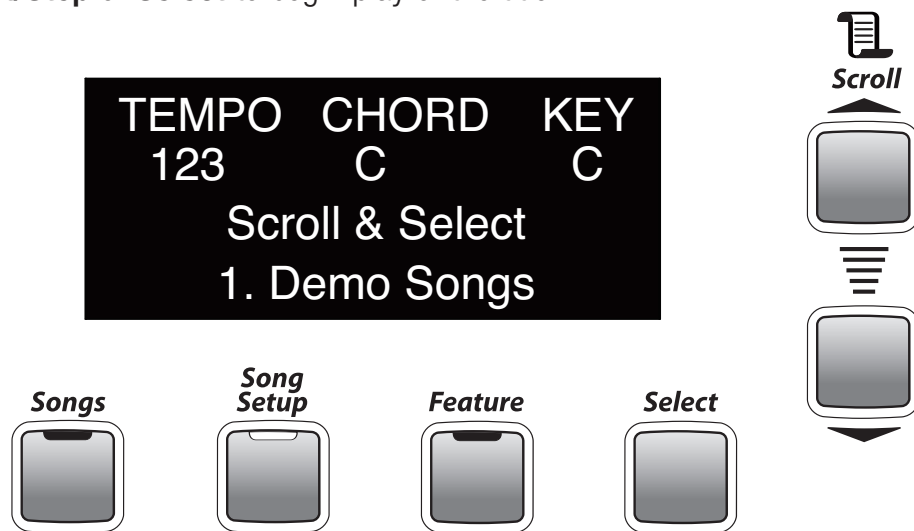

1.	Demo Songs	11.	It's A Small World After All
2.	Music! Music! Music!	12.	Amazing Grace
3.	Jingle Bells	13.	This Land Is Your Land
4.	Marianne	14.	Beer Barrel Polka
5.	When The Saints Go Marching In	15.	Oh, What A Beautiful Morning
6.	Beautiful Brown Eyes	16.	Too-Ra-Loo-Ra-Loo-Ra
7.	Little Brown Jug	17.	Just A Closer Walk With Thee
8.	Love Me Tender	18.	Aloha Oe
9.	I Walk The Line	19.	Rocky Top
10.	Bye Bye Love	20.	Paper Roses

21.	Spanish Eyes	31.	Do Re Mi
22.	Release Me	32.	Stars & Stripes
23.	Take Me Out to the Ball Game	33.	Ramblin' Rose
24.	Edelweiss	34.	Can't Help Falling In Love
25.	You Are My Sunshine	35.	Country Roads
26.	Puff The Magic Dragon	36.	Easter Parade
27.	Silent Night	37.	I Fall To Pieces
28.	Blueberry Hill	38.	House Of The Rising Sun
29.	Your Cheatin' Heart	39.	Yellow Submarine
30.	Proud Mary	40.	Turn, Turn, Turn

Headphones

You can plug in a set of stereo headphones (USE STEREO ONLY) into the Headphone jack, located on the right end of the control panel, so you can play music in private.



Before plugging in a set of headphones be sure that the **Volume Pedal** is set to minimum volume - toe-end of the pedal all the way up, as illustrated here.

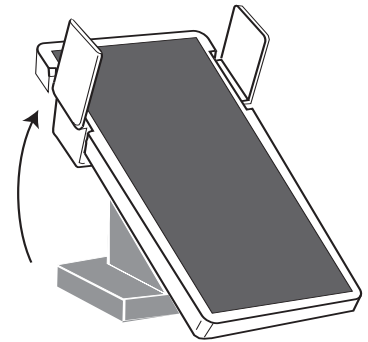

When headphones are plugged into the headphone jack the speaker system is muted. The volume of the headphones will be controlled with the **Volume Pedal**, just like the speaker system of the EZ10.

SLOWLY increase the headphone volume to a comfortable level.

Setups

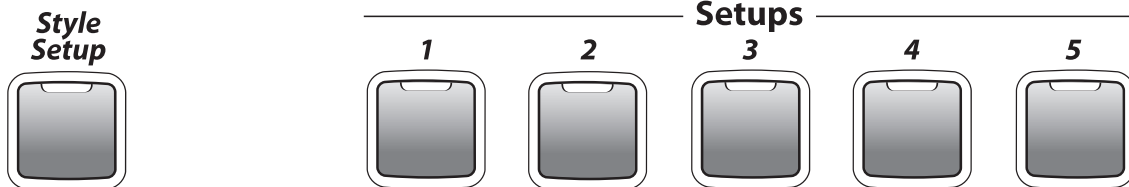

The EZ10 features six complete upper and lower keyboard sound setups.

- When you first turn the EZ10 on you get Virtual Orchestra - the **Power On** sound, which is...

Upper Keyboard: *Orchestral Strings + French Horn*

Lower Keyboard: *Grand Piano*

Press one of the five numbered buttons to get a different sound for the **upper keyboard** and **lower keyboard, right of the split point.**

1. Upper Keyboard: Piano
Lower Keyboard: Vibes
2. Upper Keyboard: Spanish Guitar
Lower Keyboard: Breathy Flute
3. Upper Keyboard: Lowrey Organ
Lower Keyboard: Breathy Tenor Sax
4. Upper Keyboard: 102 Strings
Lower Keyboard: Violin
5. Upper Keyboard: Tabernacle Choir
Lower Keyboard: Chimes

Style Setup

The **Style Setup** button uses the same five numbered **Setups** buttons as above and provides six complete upper and lower keyboard sound setups for each **Music Style**.

- Press a **Music Style** button and any one of the **Performer** buttons.
- The **Style Setup** button will be lighted red.
The first complete sound setup for the selected Music Style is already active.
- Press any one of the numbered **Setups** buttons for a different sound setup for the selected Music Style.

To select your own sounds for a selected Music Style press the Style Setup button off.

Song Setup

Song Setup gives you 100 great sounding setups that are inspired by certain song titles, plus 10 classic organ setups. A listing of the song titles is in the back of this guide. **Song Setup** takes the guesswork out of selecting **Styles** and **Sounds** for many songs.



- Press the **Song Setup** button.
With **Ach Du Lieber** shown in the **Display...**
Pressing the bottom **Scroll** button moves to the very end of the list.
Pressing the top **Scroll** button moves to the next selection at the top of the list.
The complete **Song Setup List** is on page 31.
- Press either **Scroll** button to choose from the 110 setups.
- Press and hold either **Scroll** button to accelerate through the listing.
- The **Display** shows the active selection.
- Press the **Select** button when the desired title is shown in the **Display**.
- Begin playing your song.

You will discover that Song Setups are appropriate for many different songs, not just the one given in the EZ10 For example, the setup for Anytime works well with many country music songs. Amazing Grace is a good setup for many hymns.

Music Styles



Music Styles

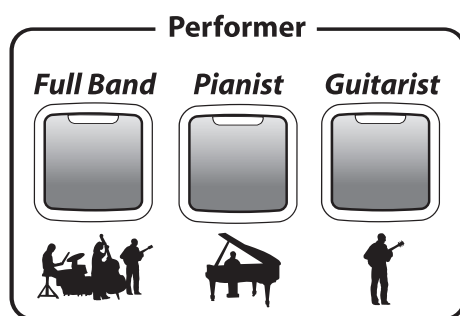
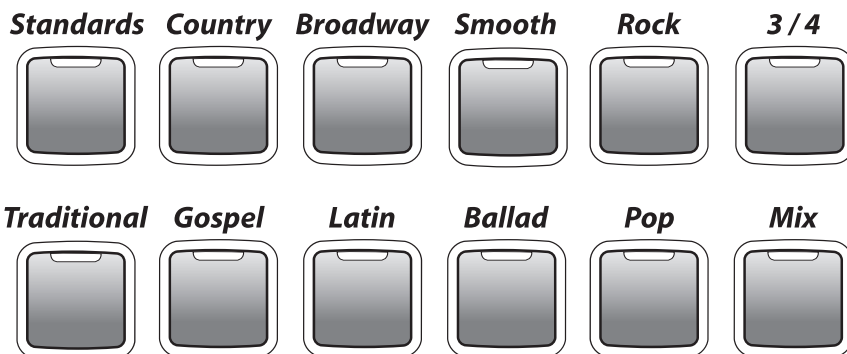

Button Name	Full Band	Pianist	Guitarist
Standards	Frank & The Count	2-Beat Piano	Guitar Swing
Country	Roadside Cafe'	Rinkie Tink	Basic Country
Broadway	Opener	Awesome Piano	The Train
Smooth	EZ 4/4	Heart Songs	Guitar 4/4
Rock	8-Beat Rock	Memphis Piano	50's Guitar Rock
3/4	EZ Waltz	Southern 3/4	Guitars 3/4
Traditional	March / Polka	Classical Piano	Jazz Guitar
Gospel	Hand Clappin'	Gospel Ballad	Guitars
Latin	Ballroom Latin	Piano Bossa	Latin Guitar
Ballad	Wonder Full World	50's Love ballad	6/8 Guitar
Pop	Pop Shuffle	Ragtime Piano	Guitar Standard
Mix	Aloha	Candelabra Piano	Basic Shuffle

Selecting a Style

Press one of the **Style** buttons. The LED will light red.

The **Full Band** Performer button lights red along with the **Start/Stop**, **Easy** and **Style Setup** buttons.

To select a different **Performer** group for the chosen **Style** simply press **Pianist** or **Guitarist**.

The lower keyboard splits, as shown below. See **Features** to adjust the Split location.

- Play your melody notes on the upper keyboard and on the lower keyboard right of the split point.
- Play your accompaniment chords on the lower keyboard left of the split point.

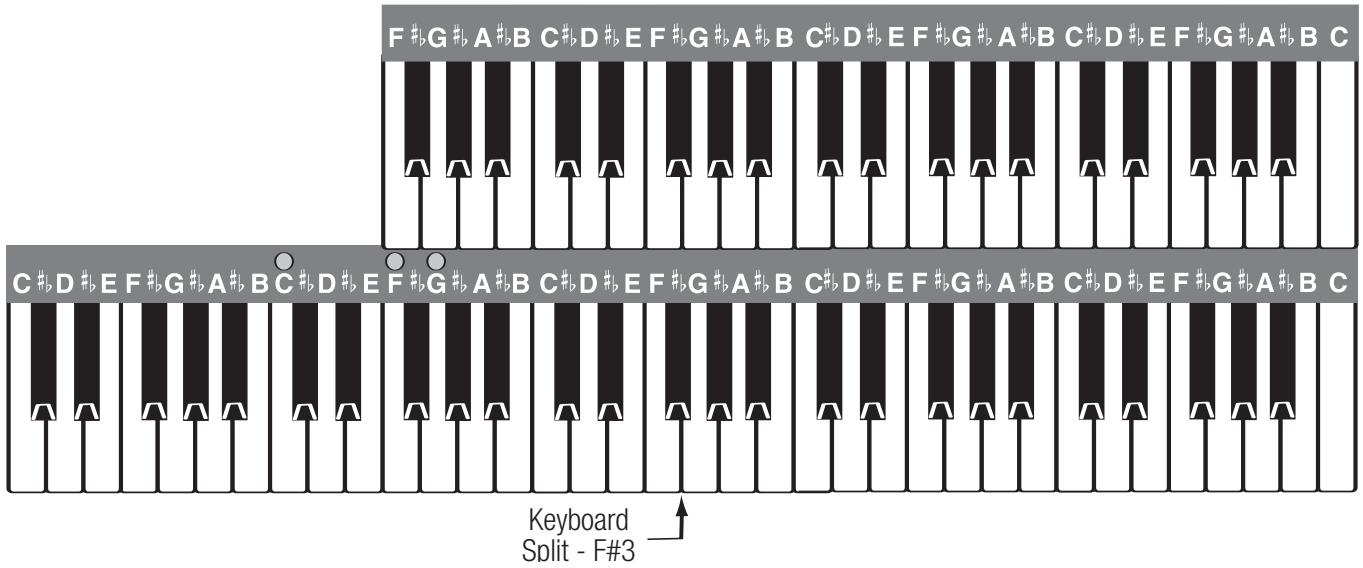

Style Controls

A number of features can operate along with or control aspects of the **Music Styles**.

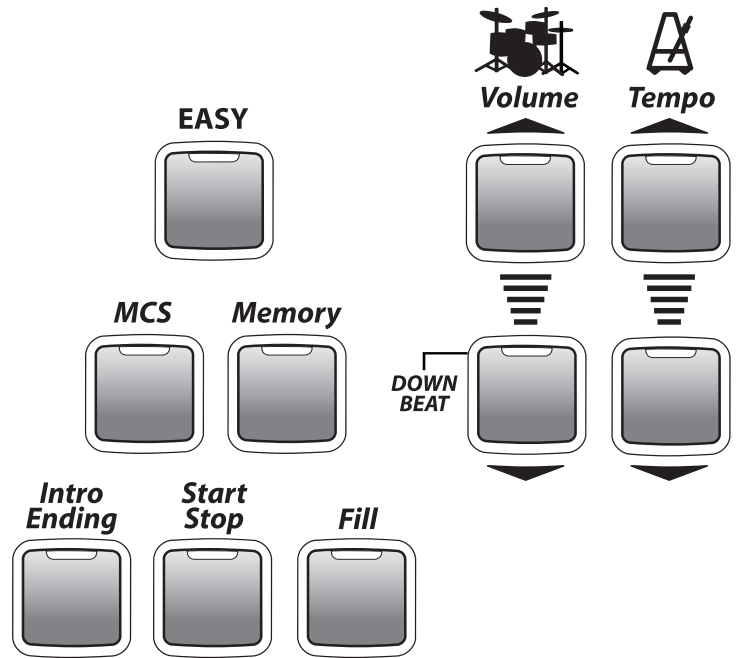

Volumes

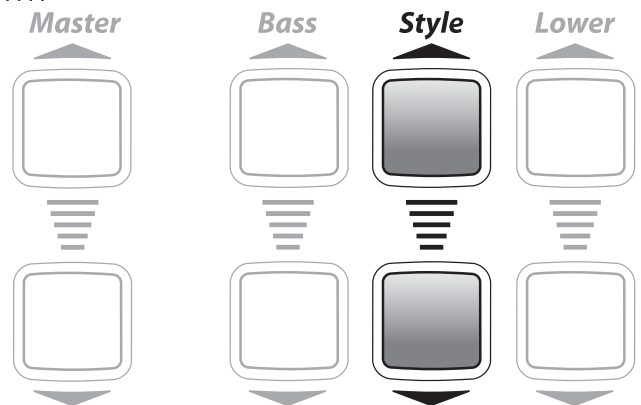

Control volume with the **Style** volume buttons.

- The top button increases the volume level.
- The bottom button decreases the volume level.

You may need to press either button several times to reach the desired level.

Control the volume of the **Drum** sounds within a **Style** using the **Drum** volume buttons.

- The top button increases the volume level.
- The bottom button decreases the volume level.

You may need to press either button several times to reach the desired level.



Downbeat Indicator - When a **Style** is playing the four buttons of the **Drum** volume and **Tempo** flash in time with the tempo. The bottom Drum volume flashes on the the **Downbeat** of the Style - the first beat of a measure.

Tempo - Each **Style** has a preset Tempo.

To increase or decrease the **Tempo** press the up or down buttons.

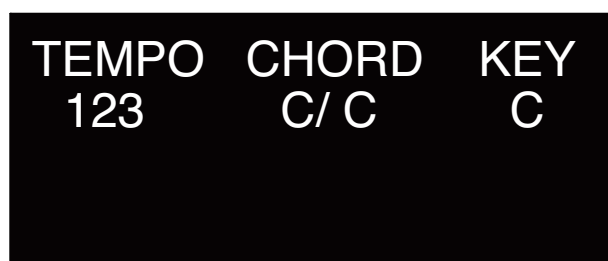
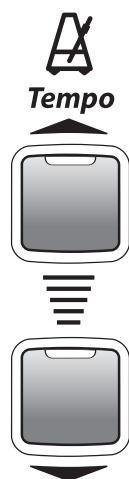

- Press either button repeatedly to achieve the desired **Tempo**.
- Press and hold either button to accelerate the change in value.
- The value of the **Tempo** can be seen in the **Display** along with...

Chord - lower keyboard chord/bass pedal being played

Key - the key at which the EZ10 is set

Lock Tempo keeps the tempo setting from changing, even though different **Styles** or **Style Setups** may be selected that would normally change the tempo.

- Press both **Tempo** buttons at the same time to lock the current tempo setting.
- To unlock the tempo press either Tempo button.

EASY - Just as **Style Setup** takes care of the right hand/upper keyboard, **EASY** sets up sounds for the left hand/lower keyboard. **EASY** also activates three features that support lower keyboard play: **Auto Bass**, **Chord Memory** and **MCS (Music Chord System)**. See page 9.



MCS lights above the lower keyboard match the color-coded chord symbols in your black *Lowrey Songbook* and the music used in the *Lowrey Magic* course.

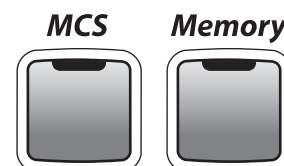

Red is **C**, blue is **F**, green is **G**. MCS responds in a musically correct fashion when you play multi-fingered chords or single-fingered chords.



Major Chord - Any major chord can be played with the conventional three notes or a single note. For example, to play a **C Major** chord with one finger play the second **C** key in the left hand / lower keyboard section of the keyboard.

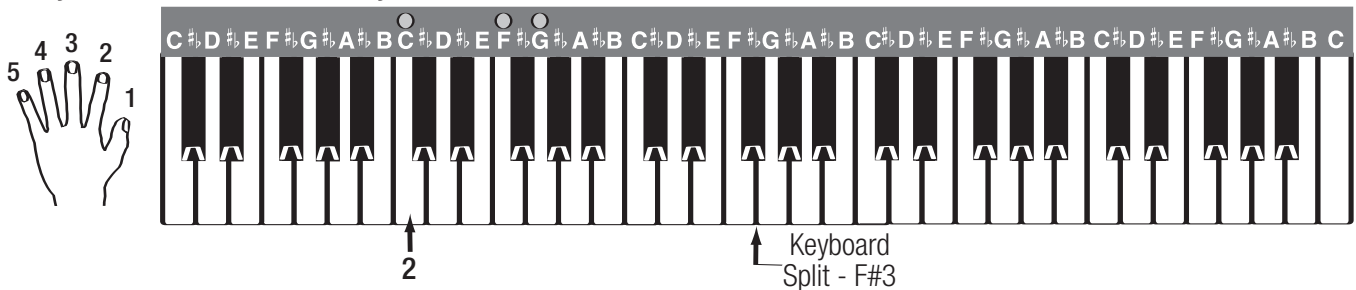

Minor Chord - Any minor chord can be played with the conventional three notes or with two notes. The two note Minor Chord formula for **MCS** is... *chord letter name + three notes up*.

- The first note to play is the letter name of the chord.
- The second note to play is three up (to the right) of the first note.

For example, to play a **C Minor (Cm)** chord play the **C** note and the black **E^b** note to the right of C. Play both keys at the same time.

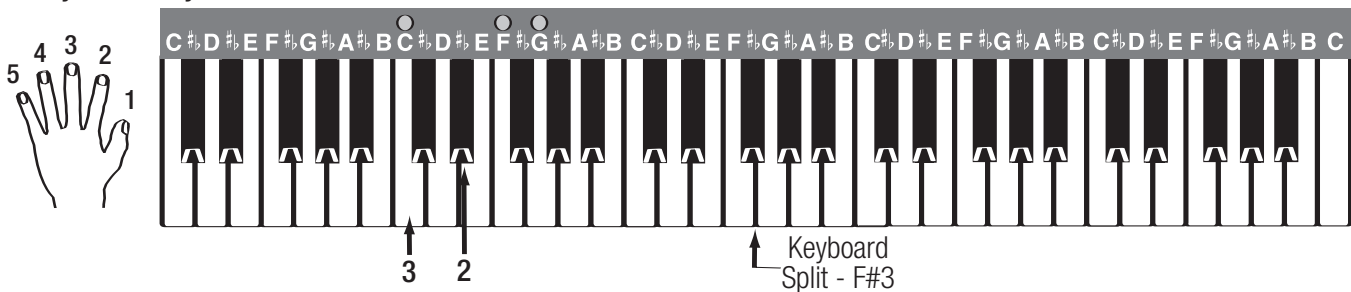

Seventh Chord - Any seventh chord can be played with the conventional four notes or with two notes. The two note Seventh Chord formula for **MCS** is... *chord letter name + two notes down*.

- The first note to play is the letter name of the chord.
- The second note to play is two down (to the left) of the first note.

For example, to play a **C Seventh (C7)** chord play the **C** note and the black **B^b** note to the left of C. Play both keys at the same time.

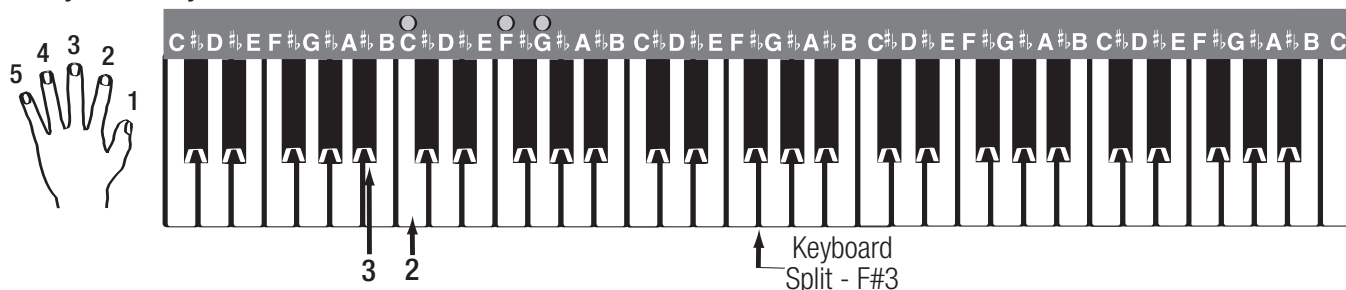

No Chord - Written as N.C. in your music, No Chord can be achieved using MCS by playing a group of three, four, or five consecutive keys at the same time on the Lower Keyboard, as illustrated below. For example: C, C#, D or F, F#, G, A, A^b.

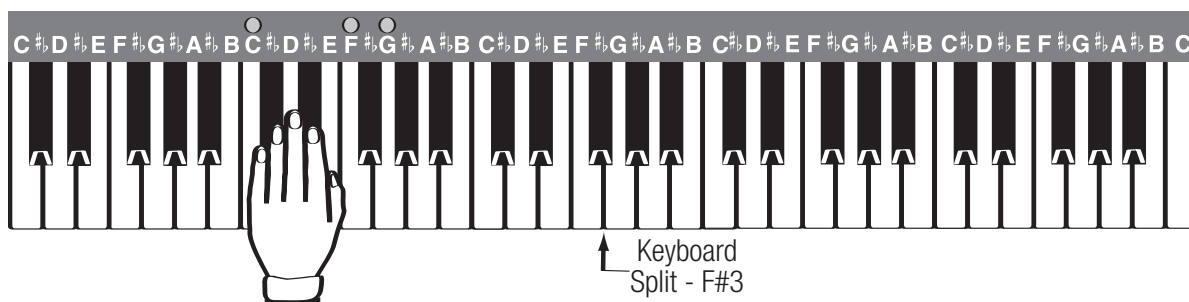

The **MCS Chord Chart** in the back of this guide lists the notes needed to form a variety of chords using **MCS** in addition to the examples given.

Memory continues sounding the last MCS chord played, even after the key or keys have been released. Turn the button off to hear your MCS chords only when you are playing the key(s).

Intro Ending adds introductions and endings to your songs.

There are unique introductions and endings for each Music Style.

- Press the **Style** button for your song. Use **Full Band** or select one of the other **Performer** options.
- Press the **Intro Ending** button.
- Play the first lower keyboard chord of your song; conventional or MCS.

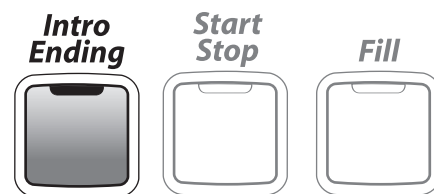

You can start the Introduction by pressing the **Start/Stop** button in place of playing a chord.

- Begin playing your song when the introduction is through and the **Style** is playing. Watch the **Display** for a cue when to play.
- When you are finished playing your song, lift your left hand off of the keys and press the **Intro Ending** button again to hear a professional sounding ending.

Minor Chord Intro - Hear a different introduction to the **Styles**.

- Select a **Style**, select a **Performer**, press **Intro Ending** and start by playing a **Minor Chord**; conventional or MCS.

Start/Stop - The Start Stop button becomes lighted when a **Style** button is selected.

- Press **Start/Stop** to start a **Style** playing. The button light turns off.
- Press **Start/Stop** while a **Style** is playing to cause it to stop. The button lights again.
- Press **Start/Stop** again and the **Styles** start playing again on the downbeat (first beat of a measure).

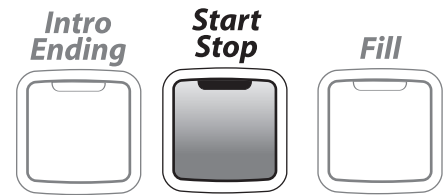

Use the **Start/Stop** to temporarily pause a **Style** without changing the setup. Any lower keyboard chord (*Easy or conventional*) will start a selected **Style** playing without pressing the **Start/Stop** button.

Fill adds a rhythmic break to a **Style** when the style is playing. **Fill** is a fun feature to use whenever you wish.

- Press the **Fill** button while a **Style** is playing.

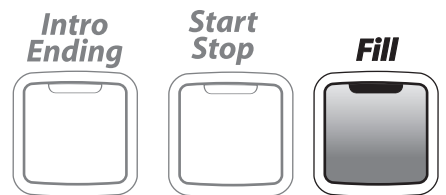

There are no set rules for using the **Fill** feature. Try using **Fill** between sections of a song (Verse to Chorus) or whenever you feel like adding a break. Press and hold **Fill** for different lengths of time to hear different variations.

Fill Fill may also be activated by pressing the **Right Foot Switch**.

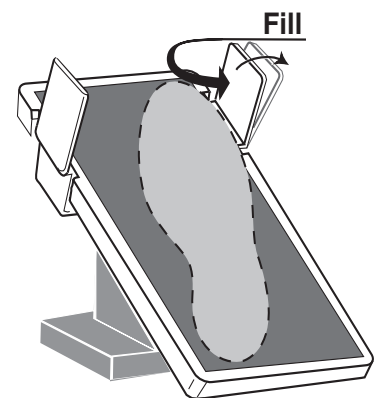

Sounds

(((Sounds)))

Upper

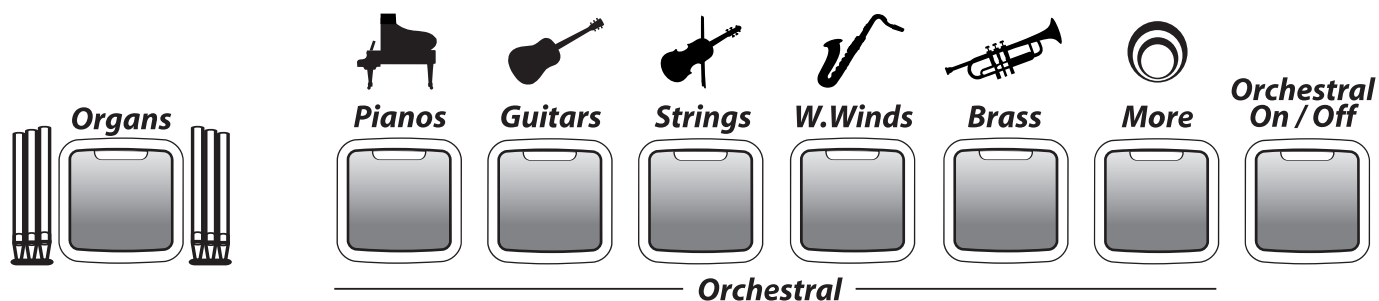

Orchestral

Lower

Vibra Trem



Fast / Slow

Bass / Pedals



Ensemble



More



Orchestral



to
Right Split

Fake It!



Instrumental sounds for the upper keyboard, lower keyboard and bass pedals are arranged in categories of instruments in the **Sounds** section.

- Press one of the instrument category buttons (**Organs, Pianos, Ensemble...**).
- Press either **Scroll** button to select an instrumental sound within the selected category.
- Instrument choices are shown in the **Display**.
- Play some keys to hear the sound shown in the **Display**.
- The **More** button holds a variety of additional sounds beyond the other categories.

Upper Keyboard Sounds

The **Organ** category sounds may be used alone or in combination with the **Orchestral** sounds.

- Press the **Organs** button.
- Press either **Scroll** button to select different organ types.
- Choices are shown in the **Display**.

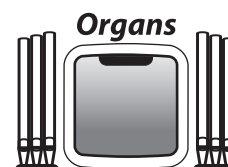

1	Sweet	6	Jazz 2	11	Mellow+Strings	16	Full+Strings
2	Rich	7	Full	12	Solo+Strings	17	Pipe+Strings
3	Mellow	8	Pipe	13	Solo+Vocal	18	Strings 16
4	Solo	9	Sweet+Strings	14	Jazz 1+Strings	19	Strings 8
5	Jazz 1	10	Rich+Strings	15	Jazz 2+Strings	20	Vocal Ensemble

Vibra Trem adds authentic organ motion to the sound, like the mechanical rotating speakers of the past.

- When the **Organs** button is selected the **Vibra Trem** feature is active and has two speeds - **Fast** and **Slow**. Button light **On** = **Fast**. Button light **Off** = **Slow**.

Vibra Trem



Fast / Slow

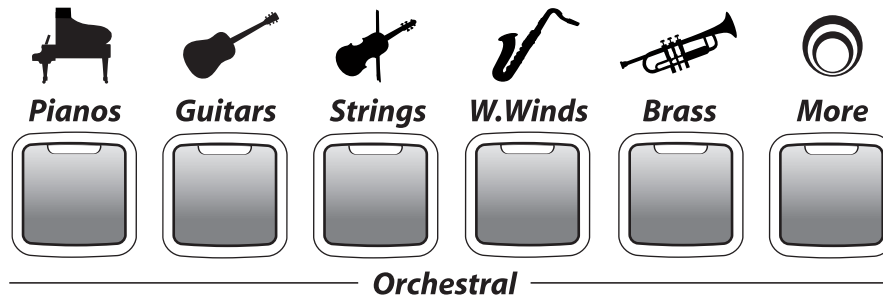

The **Orchestral** category sounds may be used alone or in combination with the **Organs** sounds.

- Press one of the **Orchestral** category buttons.
- Press either **Scroll** button to select different sounds within the category.
- Choices are shown in the **Display**.

	Pianos	Guitars	Strings	Wood Winds	Brass
1	Piano: Grand	Guitar: Acoustic	Strings: Ensemble 1	Sax: Breathy Tenor	Trumpet
2	Piano: Honky-Tonk	Guitar: Country	Strings: Ensemble 2	Clarinet	Trumpet: Muted
3	Piano-El: Detune 1	Guitar: Jazz	Pizzicato	Flute: Jazz	Trumpet: Wah-Wah
4	Piano-El: Classic	Guitar: Nylon	Violin	Oboe	Trombone: Tommy
5	Piano: Toy	Guitar: Hawaiian	Viola	Sax Section	Trombone: Jazz
6	Piano: Octaves	Guitar: Steel	Cello	Sax: Alto	French Horn
7	Piano: Society	Guitar: Elec. Strat	Fiddle	Sax: Alto Mellow	Flugel Horn
8	Harpsichord	Guitar: Elec. Rock	Harp	Sax: Baritone	Brass Section

More									
1	Accordion	11	Bells: Crystal	21	Kazoo	31	Organ: Principal	41	Scat
2	Accordion: Lyric	12	Blown Bottle (Jug)	22	Mandolin	32	Organ: Stopped	42	Scat: Swingle
3	Accordion: Musette	13	Calliope	23	Marimba	33	Organ: Tibia Soft	43	Steel Drums
4	Animal: Cat	14	Choir	24	Organ-Perc: 2 2/3	34	Organ-Combo: 60's	44	Test-Sound
5	Animal: Dog	15	Clavinette	25	Organ-Perc:4	35	Organ-Combo: Rock	45	Vibes
6	Bag Pipe	16	Ens: Big Band	26	Organ: 8' Celeste	36	Pan Flute	46	Vocal: Doo
7	Banjo	17	Guitar: Mute-Dynam	27	Organ: Baroque	37	Piano-El: Detune 2	47	Whistle
8	Bassoon	18	Guitar: Spanish	28	Organ: Church	38	Piccolo	48	Xylophone
9	Bells	19	Harmonica	29	Organ: Med. Ens.	39	Pop	49	Xtra: New Age
10	Bells: Church	20	Harmonica: Pocket	30	Organ: Mellow Ens.	40	Recorder	50	Xtra: Solo-Saw

With both the **Orchestral On/Off** and **Orchestral to Right Split** buttons lighted **Orchestral** sounds may be played on both keyboards.

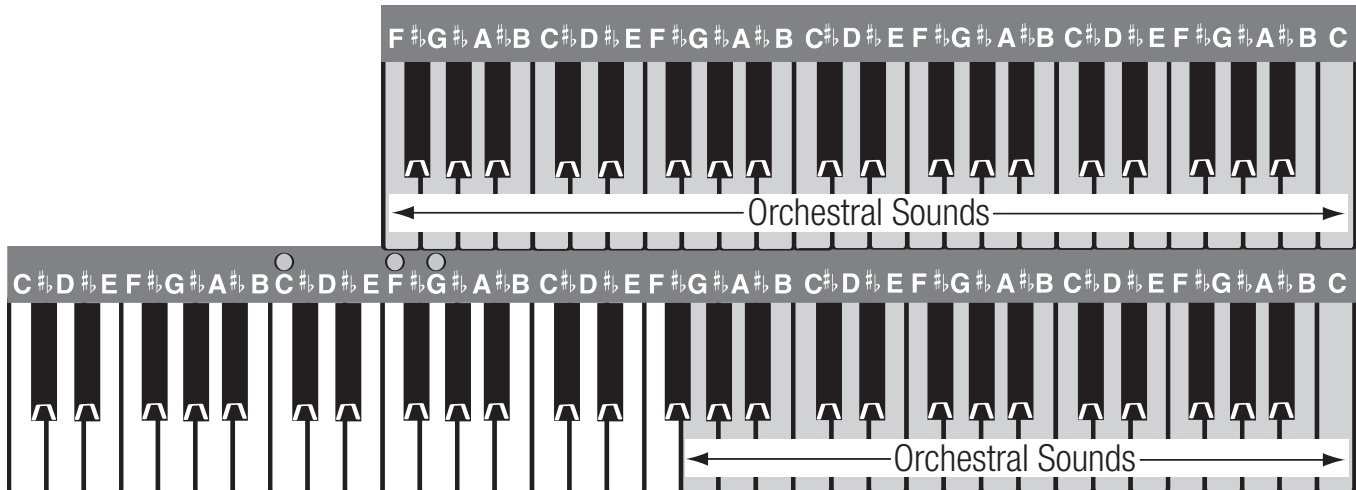

The **Lower Keyboard Split** location is preset to **F#3**. See **Features-Keyboard Split** to change the location.

Harmony is the playing of two or more notes at the same time to create a pleasant sound. Much like the **EASY** button, which makes playing left hand chords easier, **Harmony** makes right hand harmonies possible with just one finger. There are six different **Harmony** types from which to choose.



- Press the **Harmony** button.
- Press either **Scroll** button to choose a harmony type.
- The **Display** shows the active harmony type.
- The **Harmony** feature functions when...
 - You play single notes on the Upper Keyboard...*
 - While you play a chord (MCS or Conventional) on the Lower Keyboard (to the left of the split).*
- **AOC** takes all of your lower keyboard notes and adds them below the upper keyboard note being played. *Any notes within a whole step of the upper keyboard note being played may be excluded.*
- **Duet** adds one more note to the right hand/upper keyboard note being played. Duet creates a nice, light sound.
- **Open** adds two more notes to the upper keyboard melody note being played. Other times called 3-Part, this style of harmony is used by many theatre organists.
- **Octave Duet** adds one harmony note, like Duet, plus an additional note an octave below the melody note being played. Great with Accordion or orchestral strings.
- **Rock** harmony adds two notes below the upper keyboard note being played. This harmony style is often heard on electric guitar in rock n' roll and contemporary country.
- **Octave** harmony adds the lower octave note to the right hand/upper keyboard note being played. A good harmony type for piano or jazz guitar.

Fake It! is a fun and exciting feature that enables you to step out and play a professional sounding solo, or 'Riff' with just one finger. All you need to do is play a single upper keyboard key in a rhythmic fashion.

Fake It!



- Press the **Fake It!** button.
- Play single notes to hear a solo.
- Any upper keyboard sound may be used.
- **Fake It!** works with or without a **Style**.
- **Fake It!** follows your lower keyboard chord changes.

Lower Keyboard Sounds

The **Lower** category sound buttons are used to select instrumental sounds for the lower keyboard.

- Press the **Ensemble** or **More** button.
- Press either **Scroll** button to select different instruments.
- Instrument choices are shown in the **Display**.

Ensemble

More



	Ensemble	More							
1	Strings	1	Bass: Acoustic	11	Guitar: Mute-Dynam	21	Organ: Stopped	31	Pizzicato
2	Vocals	2	Bass: Electric	12	Guitar: Nylon	22	Organ: Tibia Soft	32	Sax Section
3	Vocal & Strings	3	Bass: Finger Slap	13	Guitar: Steel	23	Organ: 8' "B" Rock	33	Scat
4	Organ 8	4	Brass Section	14	Harp	24	Organ: 8' Celeste	34	Steel Drums
5	Organ 4	5	Calliope	15	Harpsichord	25	Piano: Grand	35	Strings: Ens. 1
6	Organ 8 + 4	6	Choir: Aah	16	Marimba	26	Piano: HonkyTonk	36	Strings: Ens. 2
7	Organ8+Strings	7	Choir: Ooh	17	Organ: Baroque	27	Piano: Society	37	Vibes
8	Organ 8+Vocals	8	Ens: Big Band	18	Organ: Med. Ens.	28	Piano-El: Detune 1	38	Vocal: Doo
		9	Guitar: Acoustic	19	Organ: Mellow Ens.	29	Piano: El. Detune 2	39	Xtra: Soft-Sweep
		10	Guitar: Jazz 2	20	Organ: Principal	30	Piano-El: Classic	40	Xtra: Soft-Warm

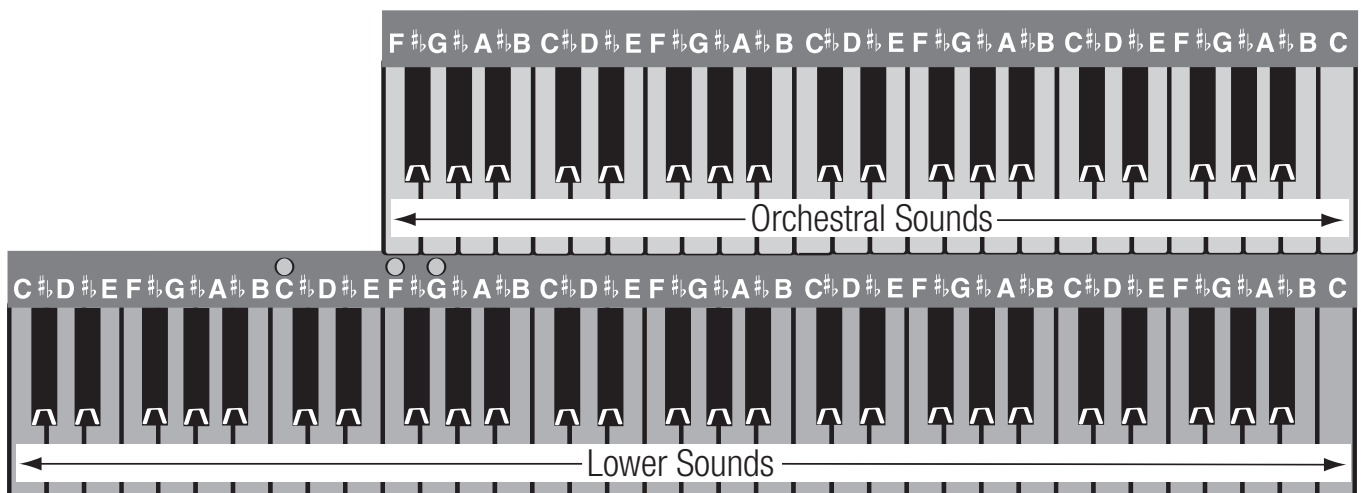

Dual Sounds

Select any two lower sounds to play together.

- Press the **Ensemble** button. Press either **Scroll** button to select a sound.
- Press the **More** button. Press either **Scroll** button to select a sound.
- Play on the lower keyboard and hear both sounds.

With the **Orchestral to Right Split** button lighted orchestral sounds play on the right side of the lower keyboard. **Lower** sounds play on the left.

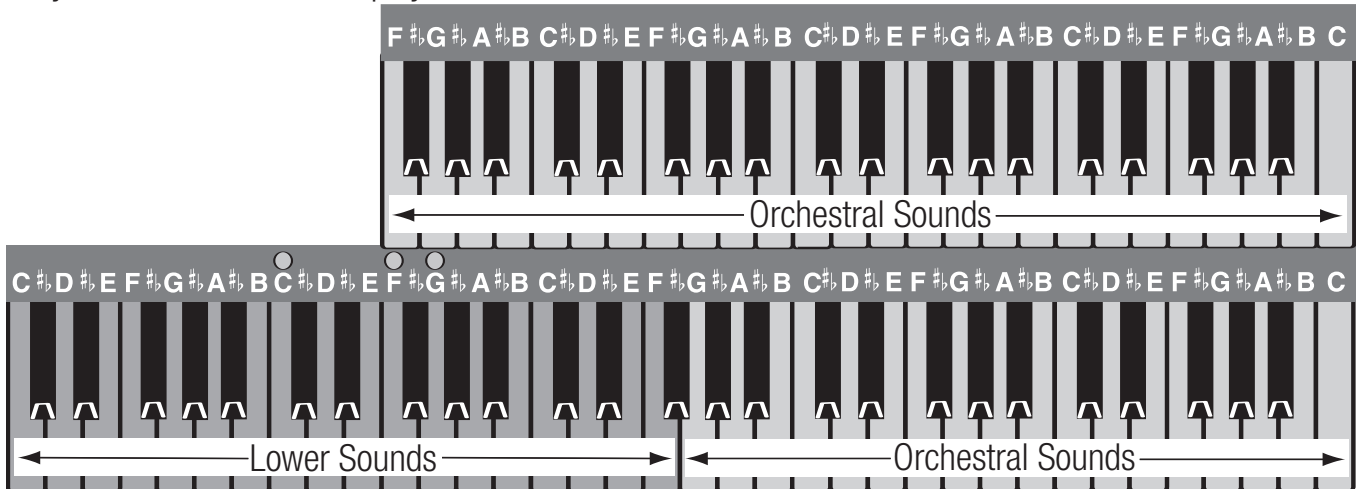

Control volume with the **Lower** volume buttons.

- The top button increases the volume level.
- The bottom button decreases the volume level.

You may need to press either button several times to reach the desired level.

Volumes

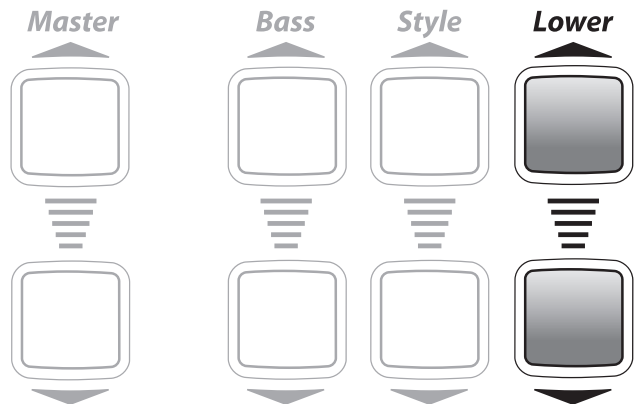

Glide / Sustain

Certain acoustic instrument sounds have the ability to **Glide** or **Sustain**. The left **Foot Switch** applies either a Glide or Sustain effect, depending on whether or not the actual acoustic instrument would **Glide**. Instruments such as guitars, and some woodwinds are able to glide. When implemented, Glide lowers the pitch of a sound one half step and then 'Slides' the sound back up to the original pitch.

Glide/Sustain

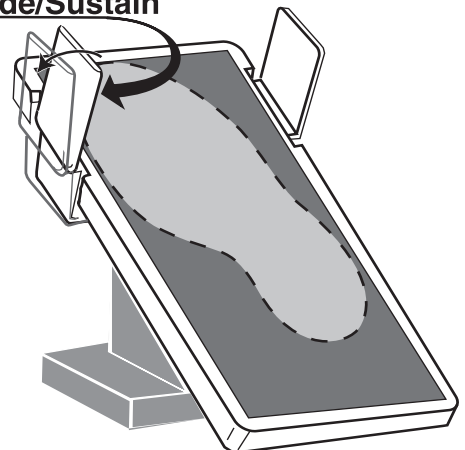

- Select a sound that would naturally **Glide**, like the **Guitar: Country** sound.
- Press and hold the left **Foot Switch**

- Play and hold the note you wish to glide.
- Release the **Foot Switch** and the note **Glides** up.

Sustain - Other instrument sounds have a characteristic called sustain. **Sustain** is the effect of a sound continuing and slowly fading away, like a piano, even after the keys are released.

- Select a sound that would naturally **Sustain**, like a **Piano**.
- Play a note, or notes,
- Press and hold the left **Foot Switch**.
- Release the key(s) and the note(s) **Sustain**.
- Release the **Foot Switch** to stop the **Sustain** effect.

Glide and **Sustain** may also be controlled using the **Bass Pedals**. See **Features - Bass Pedals**.

The **Bass/Pedal** sound button is used to select instrumental sounds for the foot pedals.

- Press the **Bass/Pedals** button.
- Press either **Scroll** button to select different instruments.
- Instrument choices are shown in the **Display**.

Bass / Pedals



Just like the upper and lower keyboard, **Bass** sounds are preset for you when turn on the EZ10, use a **Music Style**, **Style Setup**, and **Song Setup**.

Three levels of play are available for the bass pedals.

- **Conventional:** You play the pedals in order to hear bass sounds.
- **Pedal Magic:** You play the pedals and have the EZ10 assist you. See **Pedal Magic** on page 9.
- **Auto Bass:** The EZ10 plays bass for you. See **Auto Bass** on page 9.

Bass	
1	Bass: Acoustic 2
2	Bass: Tuba
3	Bass: Bow Ens.
4	Bass: Diaphone
5	Bass: Electric
6	Bass: Finger Slap
7	Bass: Piano
8	Timpani: Rolling

Control volume with the **Bass** volume buttons.

- The top button increases the volume level.
 - The bottom button decreases the volume level.
- You may need to press either button several times to reach the desired level.

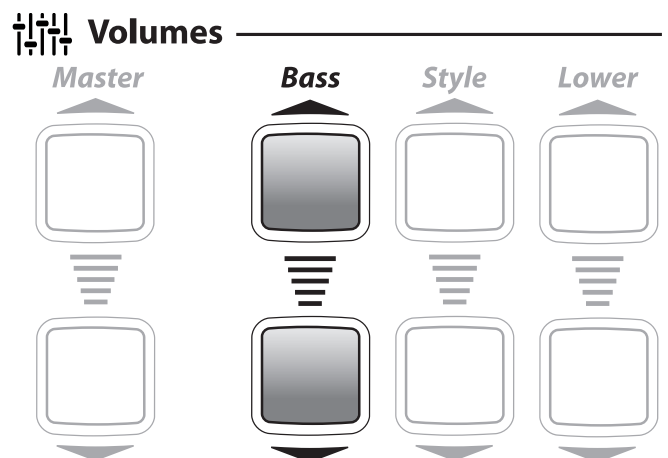

Features

There are nine **Feature** items that control certain aspects of EZ10 performance. Some **Features** are preset by Lowrey while other are player activated.

All **Feature** selections are shown on the **Display**.

Features are manipulated using the **Feature**, **Select** and **Scroll** buttons.

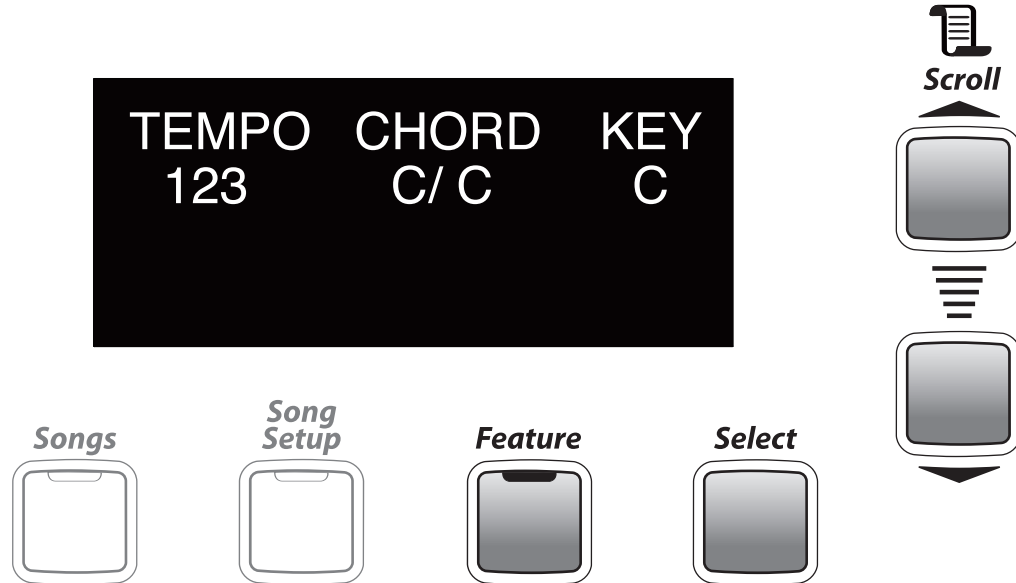

	Feature	Default Setting	Option(s)
1	Lower Split	Third F# Key (F#3)	Change location of split as described below. Split relocates to F#3 after pressing the Home button or turning the Power off.
2	Organs Sustain	On	Off
3	Touch (Key Velocity)	On	Off
4	Drums Only	Off	On
5	Keyed Bass	Off	On
6	Bass Pedals	Normal	Glide/Sustain
7	Orch. Octave	-1	-1, 0, +1
8	Orchestral Level	9 (power up)	0-10
9	Transpose	C	12 Half Steps

1. Change the location of the **Lower Keyboard Split**.

- Press the **Feature** button.
- Press either **Scroll** button to show **Lower Split** in the **Display**.
- Press the **Select** button. Key name of split location is shown.
- Press either **Scroll** button to change the location.
- Press the **Feature** button to set.

Once changed Key Split location remains for all presets until powered off or Home is pressed.

2. Turn the **Sustain** effect on or off for upper keyboard Organs category sounds.
 - Press the **Feature** button.
 - Press either **Scroll** button to show **Organs Sustain** in the **Display**.
 - Press the **Select** button. **On** or **Off** condition is shown.
 - Press either **Scroll** button to change.
 - Press the **Feature** button to set.

With Organs Sustain set to On upper keyboard Organ sounds linger and fade away after key release.

3. Turn keyboard **Touch** sensitivity on or off. Sounds are preset with the appropriate on or off setting.

Off- Keys are not touch sensitive. Expression/Volume is controlled with the Volume Pedal.

On- Keys are touch Sensitive (piano style). Expression/Volume is controlled by key touch.

 - Press the **Feature** button.
 - Press either **Scroll** button to show **Touch** in the **Display**.
 - Press the **Select** button. **On** or **Off** condition is shown.
 - Press either **Scroll** button to change.
 - Press the **Feature** button to set.

4. Turns the **Drums Only** option for **Styles** on or off.

On- Hear a **Style** with just the drum portion playing.

Off- Hear a **Style** with all of the drums and orchestration playing.

MCS chords do not operate in Drums Only mode.

 - Press the **Feature** button.
 - Press either **Scroll** button to show **Drums Only** in the **Display**.
 - Press the **Select** button. **On** or **Off** condition is shown.
 - Press either **Scroll** button to change.
 - Press the **Feature** button to set.

5. Turns the **Keyed Bass** feature on or off.

On- Play a bass sound (Bass 16' + Bass 8', with sustain) on the lower keyboard, left of the split location. When selected, a **Lower Sound** will play along with the **Keyed Bass** sound.

Off- Default setting.

 - Press the **Feature** button.
 - Press either **Scroll** button to show **Keyed Bass** in the **Display**.
 - Press the **Select** button. **On** or **Off** condition is shown.
 - Press either **Scroll** button to change.
 - Press the **Feature** button to set.

6. Select from two bass pedal operation choices.

Normal - Play the bass pedals to hear bass sounds.

Glide/Sustain - Use the bass pedals as a Glide/Sustain controller.

Use this setting in place of the Left Foot Switch to control Glide/Sustain.

- Press the **Feature** button.
- Press either **Scroll** button to show **Bass Pedals** in the **Display**.
- Press the **Select** button. **Normal** or **Glide/Sustain** setting is shown.
- Press either **Scroll** button to change.
- Press the **Feature** button to set.

While set to **Glide/Sustain**...

Glide

- Select a sound that would naturally **Glide**, like the **Guitar: Country** sound.
- Press and hold any **Bass Pedal**.
- Play and hold the note you wish to glide.
- Release the **Bass Pedal** and the note **Glides** up.

Sustain

- Select a sound that would naturally **Sustain**, like a **Piano**.
- Play a note, or notes,
- Press and hold any **Bass Pedal**.
- Release the key(s) and the note(s) **Sustain**.
- Release the **Bass Pedal** to stop the **Sustain** effect.

7. Orch. Octave- The feature changes the pitch of a sound up or down one octave without changing your hand position.

Select from three octave settings for upper keyboard Orchestral sounds (does not apply to Organ sounds).

-1 Lowers the pitch of a sound by one octave. (Default setting.)

0 Normal pitch.

+1 Raises the pitch of a sound by one octave.

- Press the **Feature** button.
- Press either **Scroll** button to show **Orch. Octave** in the **Display**.
- Press the **Select** button.
- Press either **Scroll** button to change.
- Press the **Feature** button to set.

8. Orchestral Level controls the volume level of the Orchestral sounds.

Volume ranges from 0 (no volume) to 10 (maximum volume).

- Press the **Feature** button.
- Press either **Scroll** button to show **Orchestral Level** in the **Display**.
- Press the **Select** button.
- Press the top **Scroll** button to increase volume.
- Press the bottom **Scroll** button to decrease volume.
- Press the **Feature** button to set.

9. Transpose easily changes the pitch of the EZ10 up or down. Play a song learned in one key as usual and have **Transpose** let you hear it in another.

EZ10 can be transposed up or down chromatically over the whole 12 key range. When you first turn EZ10 on it is in the key of **C**.

The Display shows the current key setting under the heading 'Key.'

- Press the **Feature** button.
- Press either **Scroll** button to show **Transpose** in the **Display**.
- Press the **Select** button.
- Press the top **Scroll** button to move the pitch up one half step each time it is pressed.
- Press the bottom **Scroll** button to move the pitch down one half step each time it is pressed.
- Press the **Feature** button to set.
- The **Display** shows the results.

*When beginning at **C** and transposing up through all 11 half steps to **B** the next step up will return to **C**. The same is true when transposing down 11 half steps to **C#**. The next step down returns to **C**.*

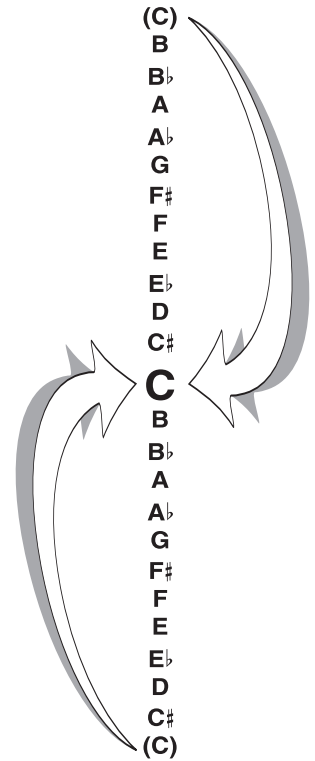

The chart illustrates how to form certain chords on the left hand/ lower keyboard using MCS:

CHORD	MAJOR (1 note)	MINOR (2 notes)	7th (2 notes)	DIM (2 notes)	AUG (3 notes)	MIN 7th (3 notes)	MAJ 7th (2 notes)	SUS 4th (3 notes)	MIN 7th \flat 5 (4 notes)
C	C	C/E \flat	C/B \flat	C/G \flat	C/E/G \sharp	C/E \flat /B \flat	C/B	C/F/G	C/E \flat /G \flat /B \flat
D \flat	D \flat	D \flat /E	D \flat /B	D \flat /G	D \flat /F/A	D \flat /E/B	D \flat /C	D \flat /G \flat /A \flat	D \flat /E/G/B
D	D	D/F	D/C	D/A \flat	D/F \sharp /A \sharp	D/F/C	D/C \sharp	D/G/A	D/F/A \flat /C
E \flat	E \flat	E \flat /G \flat	E \flat /D \flat	E \flat /A	E \flat /G/B	E \flat /G \flat /D \flat	E \flat /D	E \flat /A \flat /B \flat	E \flat /G \flat /A/D \flat
E	E	E/G	E/D	E/B \flat	E/G \sharp /C	E/G/D	E/D \sharp	E/A/B	E/G/B \flat /D
F	F	F/A \flat	F/E \flat	F/B	F/A/C \sharp	F/A \flat /E \flat	F/E	F/B \flat /C	F/A \flat /B/E \flat
F \sharp	F \sharp	F \sharp /A	F \sharp /E	F \sharp /C	F \sharp /A \sharp /D	F \sharp /A/E	F \sharp /F	F \sharp /B/C \sharp	F \sharp /A/C/E
G	G	G/B \flat	G/F	G/D \flat	G/B/D \sharp	G/B \flat /F	G/F \sharp	G/C/D	G/B \flat /D \flat /F
A \flat	A \flat	A \flat /B	A \flat /G \flat	A \flat /D	A \flat /C/E	A \flat /B/G \flat	A \flat /G	A \flat /D \flat /E \flat	A \flat /B/D/G \flat
A	A	A/C	A/G	A/E \flat	A/C \sharp /F	A/C/G	A/G \sharp	A/D/E	A/C/E \flat /G
B \flat	B \flat	B \flat /D \flat	B \flat /A \flat	B \flat /E	B \flat /D/F \sharp	B \flat /D \flat /A \flat	B \flat /A	B \flat /E \flat /F	B \flat /D \flat /E/A \flat
B	B	B/D	B/A	B/F	B/D \sharp /G	B/D/A	B/A \sharp	B/E/F \sharp	B/D/F/A

CHORD	\flat 5 (3 notes)	MIN w/MAJ 7 (3 notes)	6th (4 notes)	MIN 6th (4 notes)	DIM 7th (4 notes)	9th (3 notes)	13th (3 notes)
C	C/E/G \flat	C/E \flat /B	C/E/G/A	C/E \flat /G/A	C/E \flat /G \flat /A	E/B \flat /D	B \flat /E/A
D \flat	D \flat /F/G	D \flat /E/C	D \flat /F/A \flat /B \flat	D \flat /E/A \flat /B \flat	D \flat /E/G/B \flat	F/B/E \flat	B/F/B \flat
D	D/F \sharp /A \flat	D/F/C \sharp	D/F \sharp /A/B	D/F/A/B	D/F/A \flat /B	F \sharp /C/E	C/F \sharp /B
E \flat	E \flat /G/A	E \flat /G \flat /D	E \flat /G/B \flat /C	E \flat /G \flat /B \flat /C	E \flat /G \flat /A/C	G/D \flat /F	D \flat /G/C
E	E/G \sharp /B \flat	E/G/E \flat	E/G \sharp /B/C \sharp	E/G/B/C \sharp	E/G/B \flat /C \sharp	G \sharp /D/F \sharp	D/G \sharp /C \sharp
F	F/A/B	F/A \flat /E	F/A/C/D	F/A \flat /C/D	F/A \flat /B/D	A/E \flat /G	E \flat /A/D
F \sharp	F \sharp /A \sharp /C	F \sharp /A/F	F \sharp /A \sharp /C \sharp /D \sharp	F \sharp /A/C \sharp /D \sharp	F \sharp /A/C/D \sharp	A \sharp /E/G \sharp	E/A \sharp /D \sharp
G	G/B/D \flat	G/B \flat /G \flat	G/B/D/E	G/B \flat /D/E	G/B \flat /D \flat /E	B/F/A	F/B/E
A \flat	A \flat /C/D	A \flat /B/G	A \flat /C/E \flat /F	A \flat /B/E \flat /F	A \flat /B/D/F	C/G \flat /B \flat	G \flat /C/F
A	A/C \sharp /E \flat	A/C/G \sharp	A/C \sharp /E/F \sharp	A/C/E/F \sharp	A/C/E \flat /F \sharp	C \sharp /G/B	G/C \sharp /F \sharp
B \flat	B \flat /D/E	B \flat /D \flat /A	B \flat /D/F/G	B \flat /D \flat /F/G	B \flat /D \flat /E/G	D/A \flat /C	A \flat /D/G
B	B/D \sharp /F	B/D/A \sharp	B/D \sharp /F \sharp /G \sharp	B/D/F \sharp /G \sharp	B/D/F/G \sharp	D \sharp /A/C \sharp	A/D \sharp /G \sharp

N.C. - NO CHORD

Pressing 3, 4, or 5 half steps at the same time, for example: C, C \sharp , D -or- F, F \sharp , G, A \flat ; results in a No Chord (printed N.C. on music).

Song Setup List

Ach Du Lieber Agustine	Kum Ba Yah
Achy Breaky Heart	La Paloma
Alley Cat Song	Lady Is A Tramp, The
Aloha Oe	Love Letters In the Sand
Amazing Grace	Make the World Go Away
Anniversary Song	Marianne
Anniversary Waltz, The	Marines Hymn
Another Somebody Done Somebody Wrong Song	Melody of Love
Any Time	Michael (Row the Boat Ashore)
April Showers	Mood Indigo
Beautiful Dreamer	On The Sunny Side of the Street
Beer Barrel Polka	Our Day Will Come
Birthday Song, The	Patricia, It's Patricia
Blue Eyes	Pennsylvania Polka
Blue Velvet	Proud Mary
Bluesette	Raindrops Keep Fallin' On My Head
Brazil	Release Me
Bridal Chorus/Wedding March	Satin Doll
Can't Help Falling In Love	Seventy Six Trombones
Cherry Pink & Apple Blossom Wht.	Shadow Dancing
Church's One Foundation, The	She'll Be Comin' Round the Moutain
Down In The Valley	Shenandoah
Dream a Little Dream	Silent Night
Dry Bones	Snowbird
Edelweiss	Song Sung Blue
Five Foot Two	Spanish Eyes
Folsom Prison Blues	St. Louis Blues
Ghostriders In the Sky	Star Dust
Girl From Ipanema, The	Stars & Stripes Forever
Grandfather's Clock	Sugar Blues
Green Eyes	There Is A Tavern In The Town
Green Green Grass of Home	There's No Business Like Show ...
Happy Together	Third Man Theme
Harper Valley PTA	Twelfth Street Rag
Hava Nagila	Twilight Time
Hawaiian Wedding Song, The	Under Paris Skies
Hello, Dolly!	What Have They Done to My Song
Hernando's Hideaway	When The Saints Go Marchin In
He's Got the Whole World In His Hnd	Whispering Hope
Hey, Good Lookin'	Whistle While You Work
Hey, Mr. Banjo	Woodchoppers' Ball
Holy Holy Holy!	Yakety Sax
Honey	Yesterday
Hot Time In the Old Town Tonight	You Are My Sunshine
How Can You Mend A Brkn Heart	Your Cheatin' Heart
How Great Thou Art	<i>Pipe: Big/Choir</i>
I Can't Get Started with You	<i>Pipe: Baroque</i>
I Left My Heart in San Francisco	<i>Pipe: Quiet</i>
I'm Getting Sentimental Over You	<i>Theatre: Full</i>
In The Mood	<i>Theatre: Novelty</i>
Indiana	<i>Theatre: Soft</i>
It's A Small World	<i>Jazz Organ+Perc.</i>
Jingle Bells	<i>Full Lowrey</i>
Just a Closer Walk With Thee	<i>Lowrey + Strings</i>
King of the Road	<i>Sweet Lowrey</i>

Assembling The EZ10 Bench

【Parts】

- (A) Seat 1
- (B) Leg 4
- (C) Lock Washer 4
- (D) Nut 4
- (E) Wrench 1

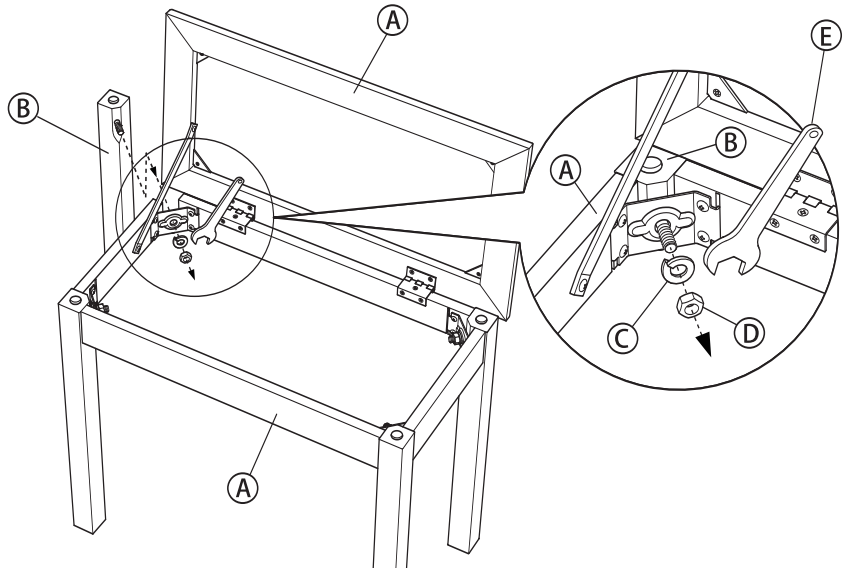

【Assembly Sequence】

1. Remove the (D) nut and the (C) lock washer from the (B) leg bolt. Insert the leg bolt through the bench seat corner bracket, as shown in the illustration.
2. Install the lock washer and then the bolt. Use just your fingers to tighten the bolt snugly at this time.
3. Repeat steps 1 and 2 for the other three legs. Again, just use your fingers to tighten the bolts snugly.
4. Once all four legs are fastened (finger tight) stand the bench on its legs. When possible you will want to stand the bench in the location where it will be used. A flat surface is satisfactory. Press down on the bench, and at the same time, gently shake it from side to side to help the parts settle into place. This step helps to achieve a solid and tight bench.
5. Firmly tighten all four bolts using the wrench provided.

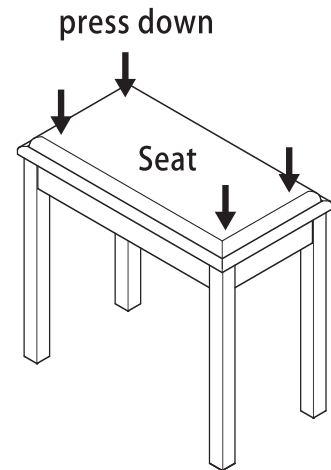

Please follow these instructions carefully and completely for your safety and comfort. A poorly assembled bench can cause injury.

【Caution】

1. Do not use this bench for any purpose other than its intended use.
2. Only one person at a time may sit on the bench.
3. Be sure all bolts are firmly tightened during the final stage of assembly.
4. Be sure to immediately retighten any bolts that may loosen over time.
5. Choking hazard: Keep assembly parts away from children.





Limited Warranty Statement

Two Year Limited Warranty Lowrey Virtual Orchestra

**Register your Lowrey product immediately by visiting www.lowrey.com
click on 'Warranty Registration'**

FIRST YEAR: Lowrey will provide the original consumer purchaser, through authorized dealers and registered technicians, component parts and authorized labor expense for installation to repair consumer's Lowrey instrument, if required due to component or material failure or workmanship.

SECOND YEAR: Lowrey will provide the original consumer purchaser, through authorized dealers or registered technicians, electronic component parts required for repair, exclusive of labor cost, if required due to component or material failure or workmanship.

This warranty is limited to instruments purchased from and will be administered through authorized Lowrey dealers in the United States & Canada and is non-transferable. Consumers are instructed to call a Lowrey dealer for service and provide accurate details of faults.

EXCLUSIONS: This warranty does not extend to accessories connected to or damages resulting from such connections; any instrument which the serial identification numbers have been altered, removed or tampered with; damage caused by abuse, neglect or improper operation; repair expenses required due to unauthorized alterations, modifications or tampering. Additional expenses of explaining features and instrument operation not included.

Lowrey shall not be responsible for any warranties offered in addition to this warranty. Lowrey shall not be liable for and excludes incidental or consequential damages which may be incurred. Implied warranties are limited to the expressed warranty. Some states do not allow these limitations. Therefore, you may have other legal rights which vary from state to state.

Lowrey maintains a policy of continuous improvement and upgrading of its instruments and therefore reserves the right to change specifications without notice or obligation.

MODEL

SERIAL NUMBER

PURCHASE DATE

EZ10



EZ10 Owner's Guide
993.048004.000
817339

Lowrey • 847 North Church Court • Elmhurst • Illinois • USA • 60126-1036

www.lowrey.com

Copyright © 2011 Lowrey Organ Company All Rights Reserved